



Profit from the Eagle Advantage®

Specification Sheet

Short Form Specifications

Eagle 1800 Series Under Bar Sink, model _____. Top, sink bowls, front and backsplash to be heavy gauge type 304 stainless steel. Sinks to be 10" x 14" x 10" deep with 1½" drains and standpipes. 4½" high backsplash with provisions for faucet with 10" spout. 1½" O.D. galvanized tubular legs with adjustable bullet feet.



model #B5C-18 underbar sink

Options / Accessories

- Stainless steel leg kits (see below)
- Leg & faucet kit (see below)
- Speed rail

Item No.: _____
 Project No.: _____
 S.I.S. No.: _____

1800 Series Underbar Sinks

MODELS:

- B3L-2-18 B5R-18
- B3R-2-18 B5C-18
- B4C-2-18 B6C-18
- B4L-2-18 B6C-4-18
- B4R-2-18 B7C-18
- B4L-18 B7C-4-18
- B4R-18 B8C-18
- B5L-18 B8C-4-18

Design and Construction Features

- New bullnose front edge.
- All units are modular, allowing for custom configuration using standard components.
- Top, front, and ends are heavy gauge type 304 series stainless steel construction.
- Back panels are galvanized steel.
- 10" x 14" x 10" (254 x 356 x 254mm) bowls.
- 1½" (38mm) drain with removable standpipe on sinks.
- Splash mount 4" (102mm) center faucet with 10" (254mm) spout.
- Available in a variety of sizes, from 3' to 8' (914 to 2438mm) length.
- Models offered with two-, three-, or four-compartment sinks, all of which are one-piece and deep-drawn.

Optional Kits for Underbar Sinks	
add suffix #	description
-SL	stainless steel leg assemblies
-SLF	stainless steel leg assemblies & stainless steel feet
-SLG	stainless steel leg assemblies & stainless steel gussets
-SLGF	stainless steel leg assemblies, stainless steel feet & gussets
-LF *	stainless steel legs and T&S faucet

* Includes #305540 stainless steel legs and #313302 T&S faucet

EAGLE GROUP
 100 Industrial Boulevard, Clayton, DE 19938-8903 USA
 Phone: 302-653-3000 • Fax: 302-653-2065
 www.eaglegrp.com

Foodservice Division: Phone 800-441-8440
MHC/Retail Display Divisions: Phone 800-637-5100

For custom configuration or fabrication needs, contact our **SpecFAB® Division**.
 Phone: 302-653-3000 • Fax: 302-653-3091 • e-mail: specfab@eaglegrp.com



EG40.07 Rev. 01/10

Spec sheets available for viewing, printing or downloading from our online literature library at www.eaglegrp.com

Eagle Foodservice Equipment, Eagle MHC, SpecFAB®, and Retail Display are divisions of Eagle Group. ©2010 by the Eagle Group

The Boelter Companies, Inc.



Profit from the Eagle Advantage®

Item No.: _____
 Project No.: _____
 S.I.S. No.: _____

1800 Series Underbar Sinks

3' (914mm) length

model #	weight	
	lbs.	kg
B3L-2-18	68	30.8
B3R-2-18	68	30.8

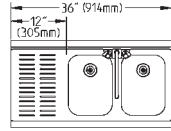

B3L-2-18

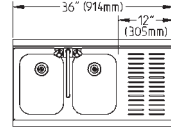

B3R-2-18

4' (1219mm) length

model #	weight	
	lbs.	kg
B4L-18	74	33.6
B4R-18	74	33.6
B4C-2-18	74	33.6
B4L-2-18	74	33.6
B4R-2-18	74	33.6

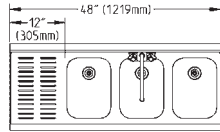

B4L-18

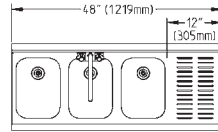

B4R-18

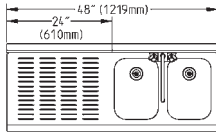

B4L-2-18

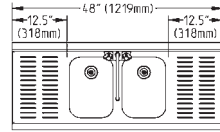

B4C-2-18

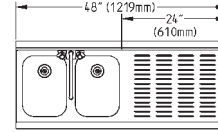

B4R-2-18

5' (1524mm) length

model #	weight	
	lbs.	kg
B5L-18	80	36.3
B5R-18	80	36.3
B5C-18	80	36.3

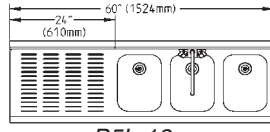

B5L-18

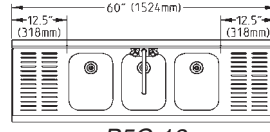

B5C-18

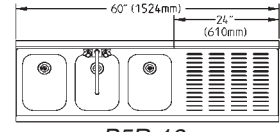

B5R-18

6' (1829mm) length

model #	weight	
	lbs.	kg
B6C-18	86	39.0
B6C-4-18	86	39.0

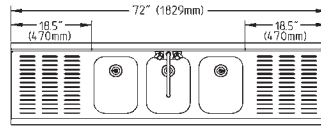

B6C-18

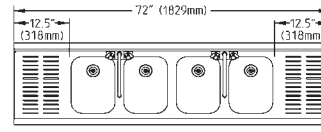

B6C-4-18

7' (2134mm) length

model #	weight	
	lbs.	kg
B7C-18	92	41.7
B7C-4-18	90	40.8

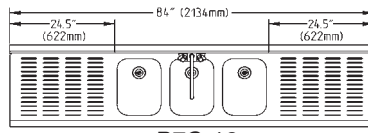

B7C-18

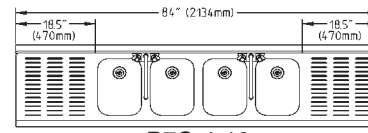

B7C-4-18

8' (2438mm) length

model #	weight	
	lbs.	kg
B8C-18	98	44.5
B8C-4-18	104	47.2

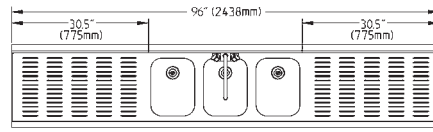

B8C-18

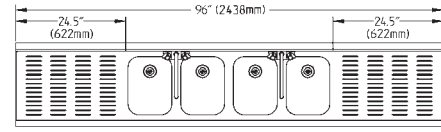

B8C-4-18

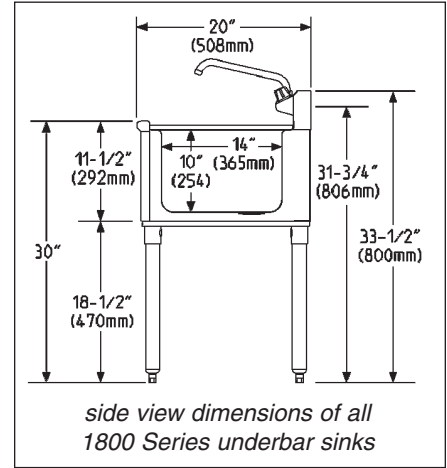

EAGLE GROUP
 100 Industrial Boulevard, Clayton, DE 19938-8903 USA
 Phone: 302-653-3000 • Fax: 302-653-2065
 www.eaglegrp.com

Foodservice Division: Phone 800-441-8440
 MHC/Retail Display Divisions: Phone 800-637-5100

Printed in U.S.A.
 ©2010 by Eagle Group
 Rev. 01/10

Spec sheets available for viewing, printing or downloading from our online literature library at www.eaglegrp.com

Although every attempt has been made to ensure the accuracy of the information provided, we cannot be held responsible for typographical or printing errors. Information and specifications are subject to change without notice. Please confirm at time of order.